

RCT-RK-04-GT-KIT enduro foot peg set

Anbauanleitung / Manual



# GILLES



**ES WIRD EMPFOHLEN DEN ARTIKEL VON EINER FACHWERKSTATT INSTALLIEREN ZU LASSEN!**

**Allgemeine Hinweise**

- Diese Anbauanleitung ist sorgfältig und vollständig vor Beginn der Einbauarbeiten durchzulesen.
- Bewahren Sie die Anbauanleitung sorgfältig auf.
- Ein unsicher aufgestelltes Motorrad kann bei den folgenden Arbeiten umfallen! Achten Sie darauf, dass das Fahrzeug sicher steht.
- Verbrennungsgefahr bei heißem Motor und Auspuff! Vor Beginn der Arbeit heiße Fahrzeugteile abkühlen lassen.
- Kinder und Tiere aus dem Arbeitsbereich fernhalten.
- Schmuck (Uhr, Ringe, Ketten, etc.) vor Arbeitsbeginn ablegen. Es besteht Unfallgefahr durch Hängenbleiben
- Die Montage und Funktion bezieht sich ausschliesslich auf Serienmotorräder.
- Nach Montage des Produkts durch eine Werkstatt, ist diese Anbauanleitung dem Kunden auszuhändigen.

**INSTALLATION RECOMMENDED BY AN OFFICIAL WORKSHOP OR DEALER!**

**General instructions**

- You must read these Installation Instructions carefully and make sure you understand everything they contain, before commencing work.**
- Please keep the instruction manual at a safe place.
- Please ensure the motorcycle is adequately secured before commencing work.
- Always make sure that the motorcycle is stable and firmly supported.  
A hot engine and exhaust system can cause injuries. Allow all hot parts to cool off before commencing work.
- Keep children and pets away from the work zone.
- Remove all items of personal jewellery (rings, chains, wristwatch, etc.) before commencing work.
- The fitment instructions relate only to the fitment on a standard motorcycle.
- If a technician is installing the parts please ensure these instructions are passed to the owner.



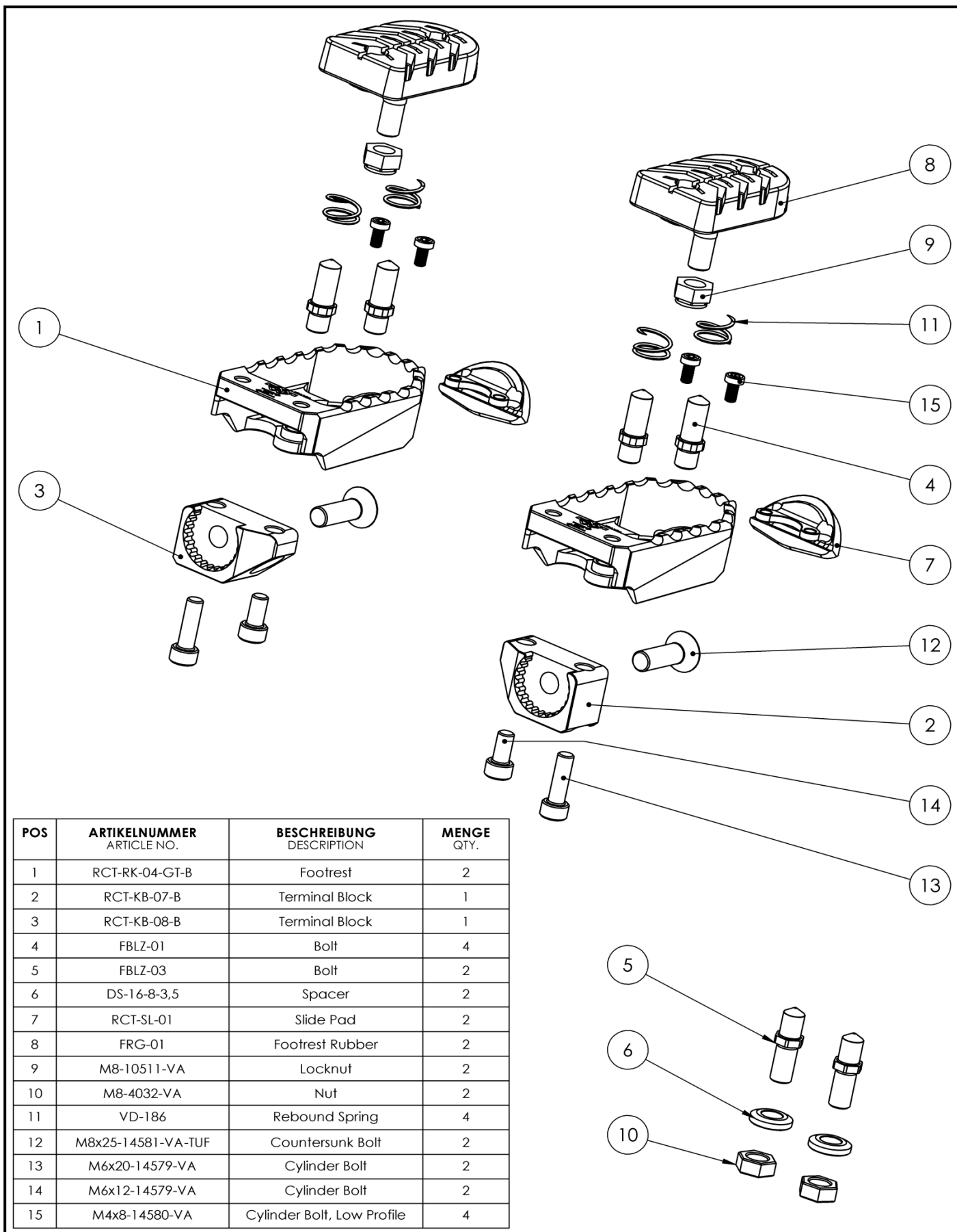

POS	ARTIKELNUMMER ARTICLE NO.	BESCHREIBUNG DESCRIPTION	MENGE QTY.
1	RCT-RK-04-GT-B	Footrest	2
2	RCT-KB-07-B	Terminal Block	1
3	RCT-KB-08-B	Terminal Block	1
4	FBLZ-01	Bolt	4
5	FBLZ-03	Bolt	2
6	DS-16-8-3,5	Spacer	2
7	RCT-SL-01	Slide Pad	2
8	FRG-01	Footrest Rubber	2
9	M8-10511-VA	Locknut	2
10	M8-4032-VA	Nut	2
11	VD-186	Rebound Spring	4
12	M8x25-14581-VA-TUF	Countersunk Bolt	2
13	M6x20-14579-VA	Cylinder Bolt	2
14	M6x12-14579-VA	Cylinder Bolt	2
15	M4x8-14580-VA	Cylinder Bolt, Low Profile	4

-Es handelt sich um Beispieldarstellungen! Ihr Anbaustatus kann leicht abweichen!

-Der Montageablauf ist auf beiden Seiten identisch (ebenso in Bezug auf benötigte Werkzeuge und zu verwendende Drehmomente).

-You see example images! Your status could be little different!

-The installation process is the same for both sides (also regarding necessary tools and recommended tightening torques).

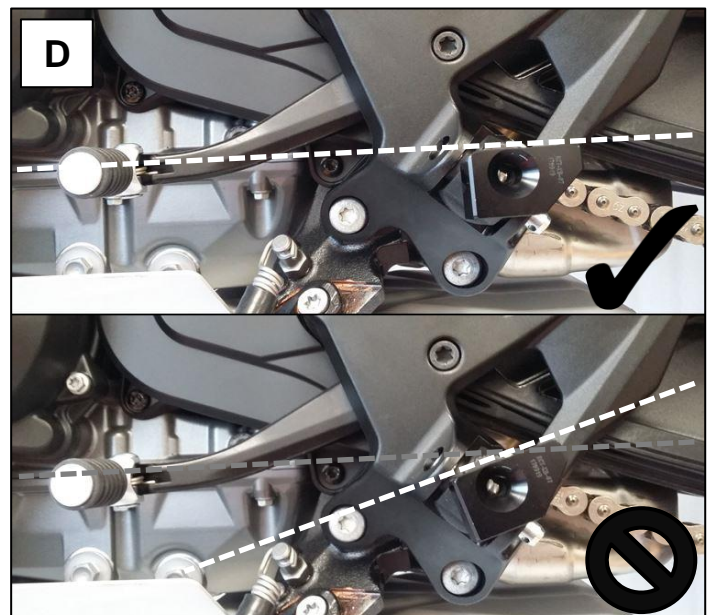
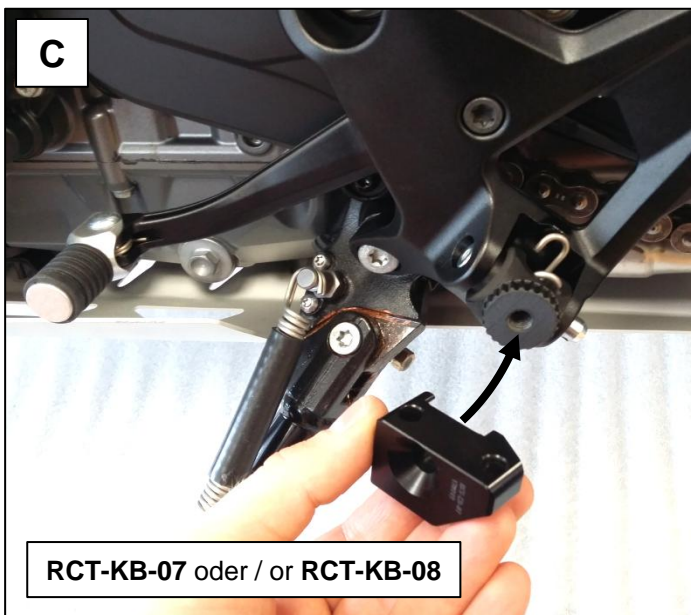
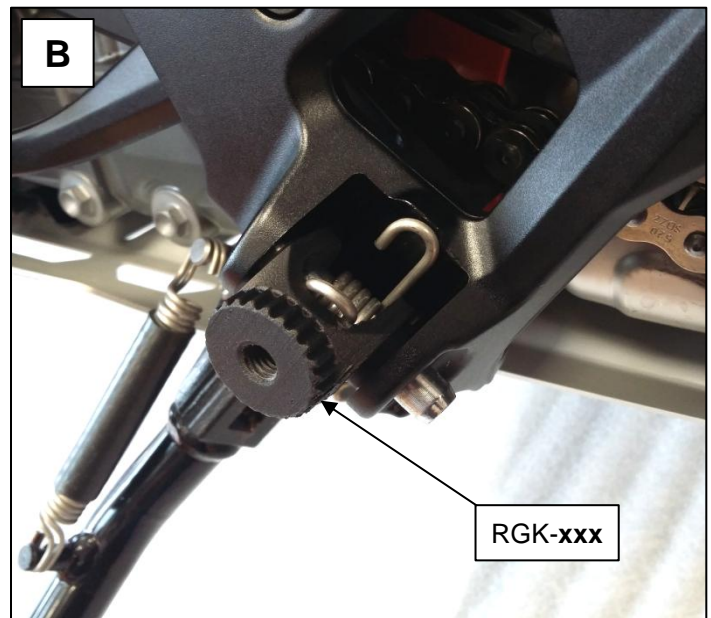
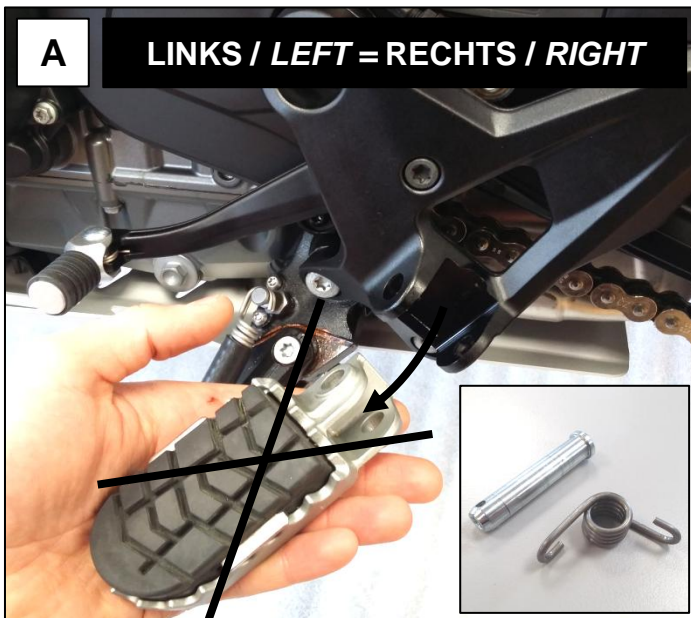

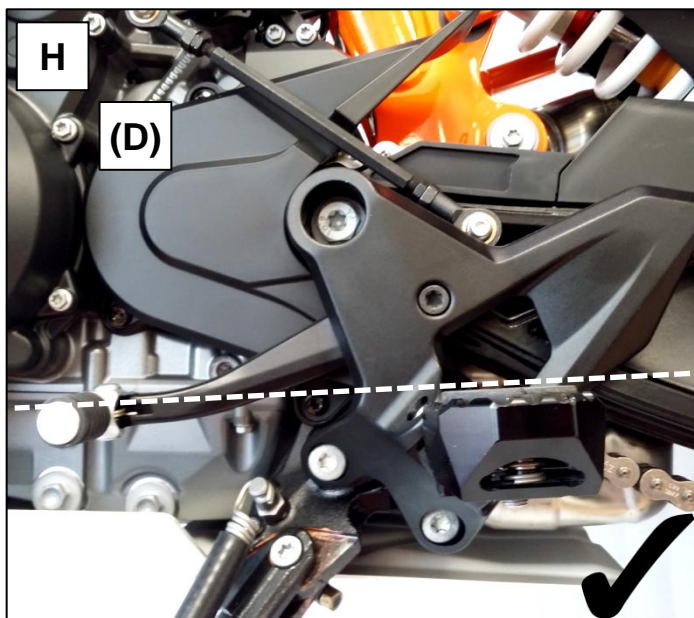
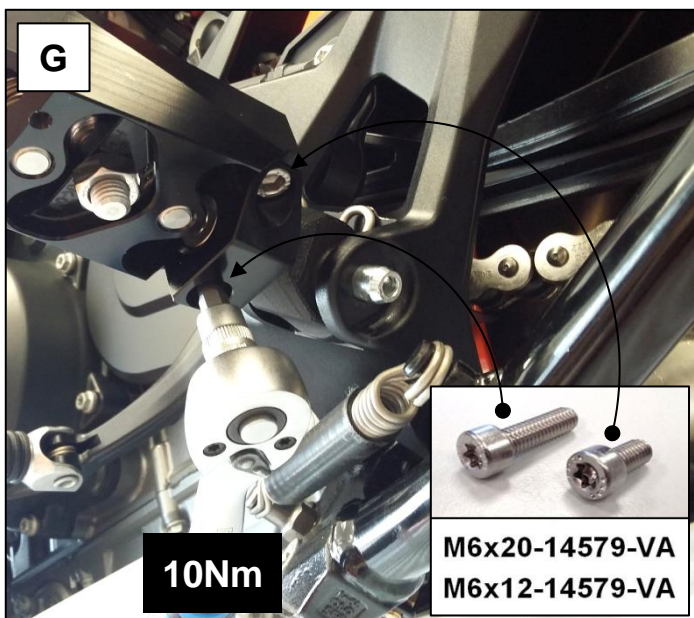
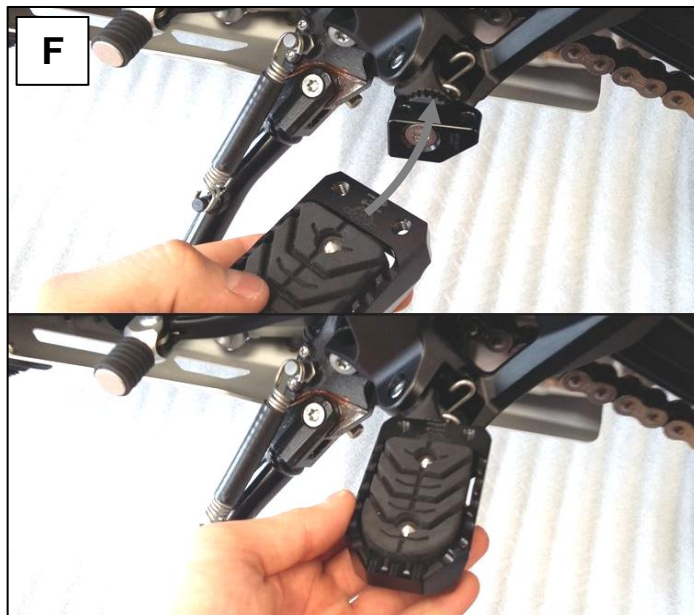
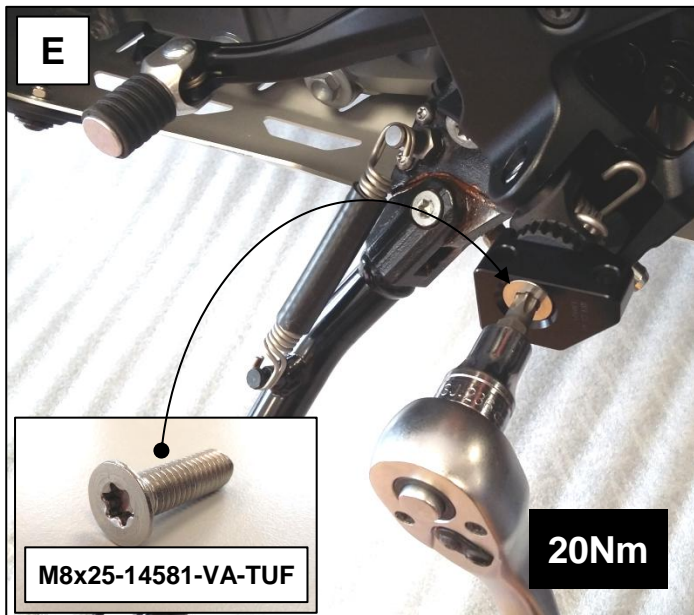

RCT-RK-04-GT-KIT enduro foot peg set

Anbauanleitung / Manual



## OPTIONALE ANWENDUNGEN UND MONTAGEMÖGLICHKEITEN

### OPTIONAL USE AND MOUNTING POSSIBILITIES

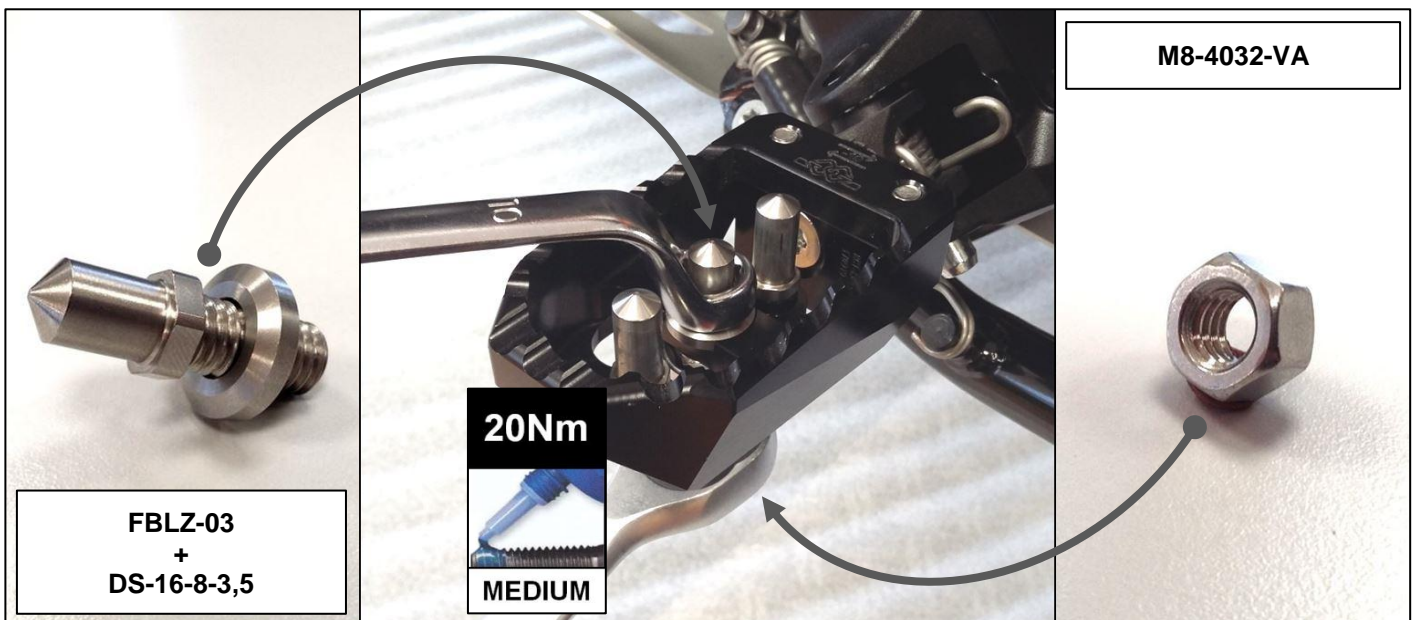
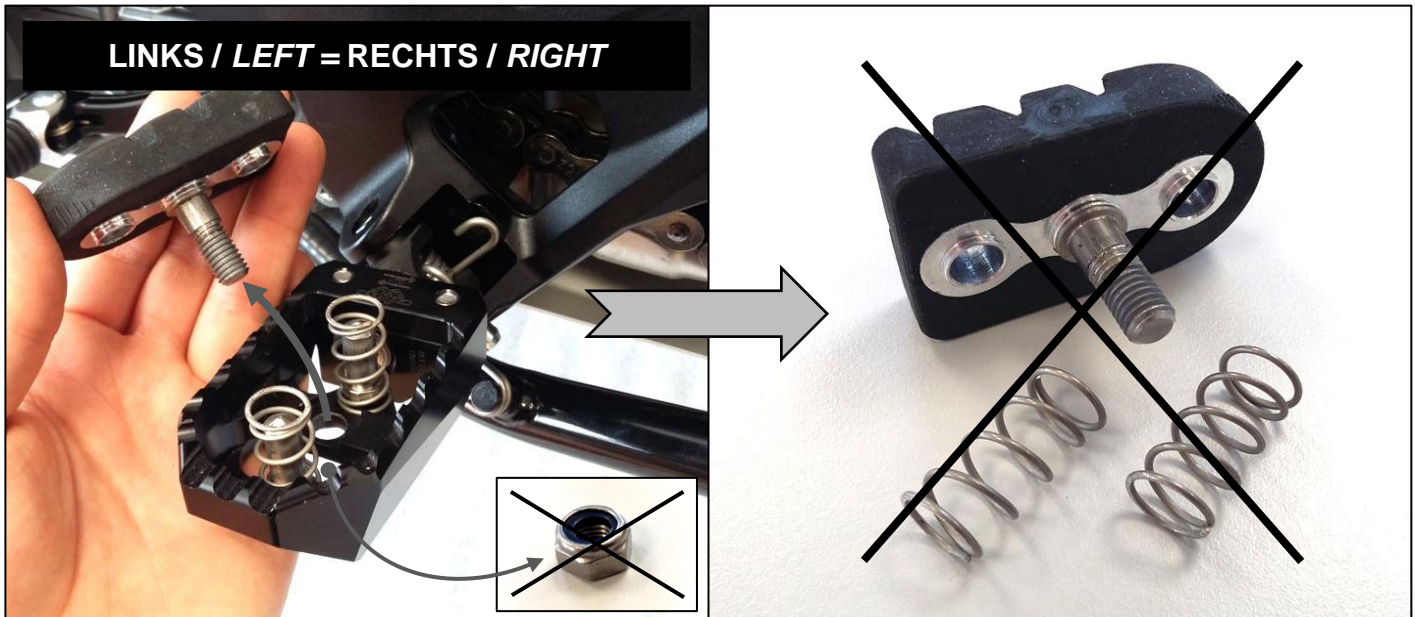

RCT-RK-04-GT-KIT enduro foot peg set

Anbauanleitung / Manual

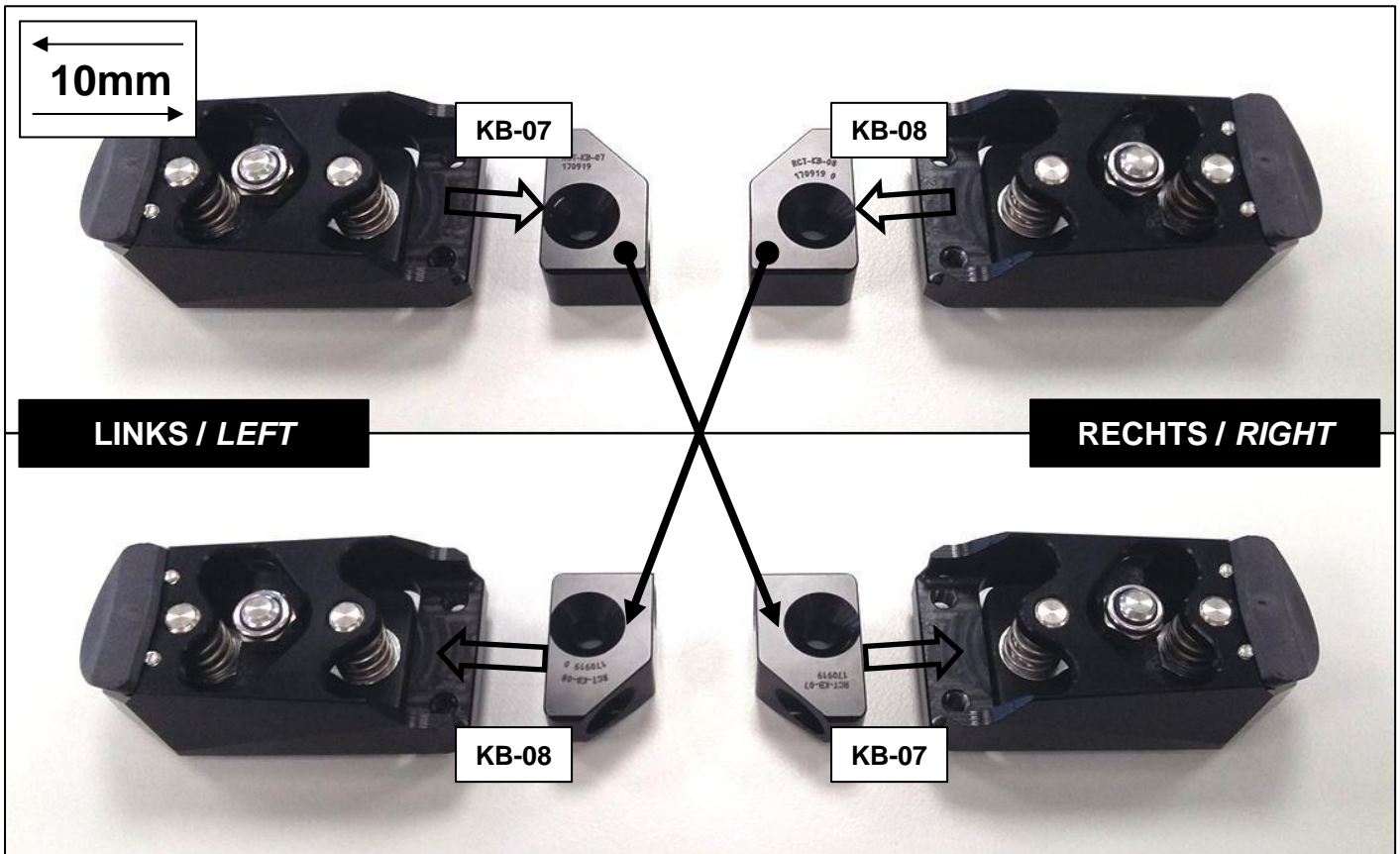

OPTIONAL VERFÜGBARES ZUBEHÖR-KIT. PLUS 20MM IN DER HÖHE.  
OPTIONAL ACCESSORY KIT AVAILABLE ALLOWS PLUS 20MM.

RCT-KB-20-KIT

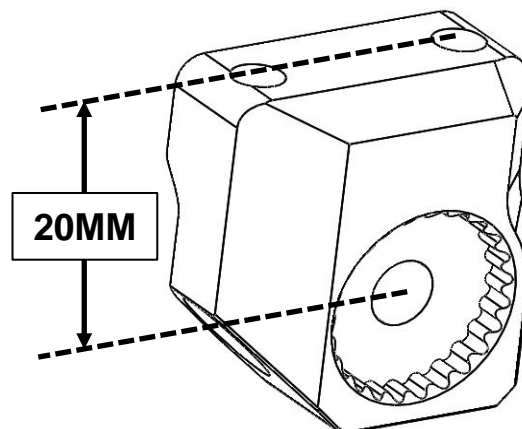
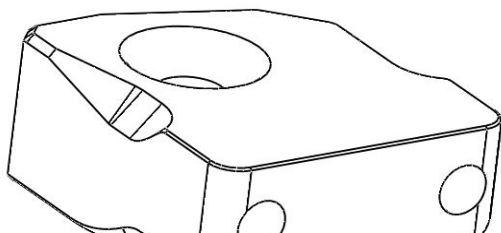

**RCT-RK-04-GT-KIT** enduro foot peg set

**Packzettel / Packing list**



Pos.	Description	Part-No.	Qty.	OK
PE-B: 165x100 (mm)				
1	Terminal Block	RCT-KB-07-B	1	
2	Terminal Block	RCT-KB-08-B	1	
PE-B: 165x100 (mm)				
3	Bolt	FBLZ-03	2	
4	Spacer	DS-16-8-3,5	2	
5	Nut	M8-4032-VA	2	
6	Cylinder Bolt	M6x12-14579-VA	2	
7	Cylinder Bolt	M6x20-14579-VA	2	
8	Countersunk Bolt	M8x25-14581-VA TUFLOK	2	
9	Manual	RCT-RK-04-KIT-ABA	1	
			<b>MA</b>	
			Datum	